

The Main Reasons for Great Damages of Reinforced Concrete Buildings on 12th November 2017, Sarpol-e Zahab Earthquake

Mohammad Ghasem Vetr^{1*}, Mahdi Saeidian², and Aran Naserpour³

1. Assistant Professor, Structural Engineering Research Center, International Institute of Earthquake Engineering and Seismology (IIEES), Tehran, Iran,

* Corresponding Author; email: vetr@iiees.ac.ir

2. M.Sc. Student, International Institute of Earthquake Engineering and Seismology (IIEES), Tehran, Iran

3. Graduated Research Assistant, International Institute of Earthquake Engineering and Seismology (IIEES), Tehran, Iran

Received: 30/12/2017

Accepted: 29/09/2018

ABSTRACT

Reinforced concrete multistory buildings in Kermanshah Province, Iran, have been subjected to a strong ground motion during Sarpol-e Zahab earthquake of November 12, 2017. A wide number of Reinforced concrete buildings have been damaged in this earthquake. It has been observed that the principal reasons for the failure are the poor quality of construction materials and defects in the implementation of structural components. Some common imperfections were short columns in the stair-boxes, insufficient reinforcements at the concrete joints, inappropriate bends and splice of rebar, wide spacing of transverse reinforcements, inaccuracy in concrete mixing plans, and lack of conjunction between structural and nonstructural members. This investigation is based on the observations of IIEES reconnaissance team. The main objective of this research is to evaluate the seismic performance of reinforced concrete multistory buildings during the Sarpol-e Zahab earthquake and vulnerability assessments of important multistory reinforced concrete structures such as Mehr buildings of Sarpol-e Zahab, Eslamabad-e Gharb, and Imam Khomeini hospital in Eslamabad-e Gharb, Kermanshah Province.

Keywords:

Sarpol-e Zahab Earthquake; Reinforced concrete buildings; Seismic performance; Vulnerability assessment

1. Introduction

Sarpol-e Zahab Earthquake took place in Kermanshah Province in Iran at 18:18 UTC (21:18 local time) on November 12, 2017, with the magnitude of 7.3. The epicenter had a distance of about 5 km to Ezgeleh city and the most distribution of damage was observed in Sarpol-e Zahab, Eslamabad-e Gharb and Qasr-e Shirin regions. It became a catastrophe of at least 530 deaths and 9400 injuries, according to the state-run news agency (IRNA). In addition, At least eight people were killed and 535 people were badly injured on the Iraqi side of the border, according to Dr. Saif

al-Badir, a spokesman of the Health Ministry of Iraq [1-4].

Among all seven cities and approximately 2000 villages affected by the strong ground motions, 4500 urban buildings, and 11500 rural settlements were subjected to severe damage. Based on the data collected by the structural department of BHRC, in Sarpol-e Zahab earthquake, a comprehensive census evaluation has been carried out on 95000 structures in Kermanshah Province. The results have revealed that about 83000 structures were damaged, 18000 of which were completely collapsed [5-8].

Presented herein is a brief discussion, based primarily on the data gathered during the comprehensive site survey of the reconnaissance team of IIEES regarding the seismic performance of damaged RC buildings in the Sarpol-e Zahab earthquake, in an attempt to give an overview of the event and its consequences. Moreover, the background of seismic design rules of RC buildings and the suggestions to prevent the severe damage in RC structures during the future earthquakes, based on RC seismic codes and rehabilitation guidelines, are also briefly discussed in this study. It has been observed that RC constructions and design practice in Kermanshah Province are similar to those in many other parts of Iran and the world. Therefore, some of the lessons learned are directly relevant to the international community for the further research, altering the general attitude of the engineering community in Iran regarding seismic design, improvements to current seismic design codes and performance criteria, and beg the implementation of most recent and most advanced technology [5-8].

2. Seismicity of the Sarpol-e Zahab Earthquake

The most significant strong ground motions in the history of this area which caused widespread number of collapsed structures and heavy casualties date back to 958 and 1150 CE. The epicenter of the Sarpol-e Zahab earthquake was located at 34.88°N and 45.84°E near the Iran-Iraq border with a shallow depth of 23 km, based on the data collected in National Center of Broadband Seismic Network

of Iran at IIEES [3]. The corrected acceleration characteristics of the excitations in Sarpol-e Zahab, Kerend-e Gharb, Eslamabad-e Gharb and Kermanshah stations reported by the BHRC have been depicted in Table (1). Among all records, the highest value recorded in Sarpol-e Zahab station [3, 6-9].

This main shock resulted in widespread liquefaction and damage to land, residential buildings, and infrastructures in the Kermanshah Province. Besides, the Sarpol-e Zahab earthquake had 1080 aftershocks with the magnitude ranging from 1.8 to 4.8. Aftershocks recorded by the Iranian Seismological Center (IRSC) have been illustrated in Figure (1) [3].

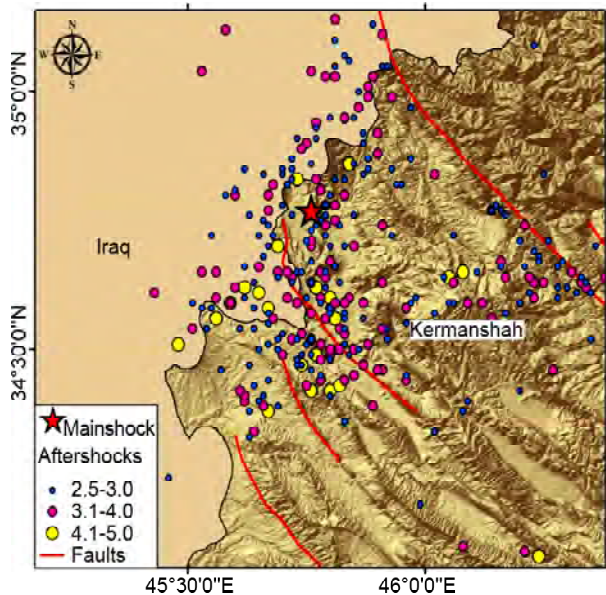

Figure 1. Aftershocks distribution of the Sarpol-e Zahab earthquake [3].

Table 1. Characteristics of the excitations in Sarpol-e Zahab, Kerend-e Gharb, Eslamabad-e Gharb and Kermanshah stations [3, 6-9].

Station	Comp.	PGA (cm/s ²)	Sus. PGA (cm/s ²)	Mean Prd. (s)	Sig. Dur. (s)	Brak. Dur. (s)
SPZ	N	686	366	0.39	10.8	24.6
	E	563	517	0.32	9.8	29
	Z	325	298	0.28	10.5	29.4
KRD	N	204	161	0.54	15	47
	E	283	244	0.57	15.6	41.7
	Z	115	102	1.02	22.4	48.4
ELA	N	124	77.4	1.15	35.5	78
	E	95.6	87.9	1.16	37.3	88
	Z	55.2	39.6	1.4	44	86.8
KRM1	N	58.3	43.6	1.03	27.5	70
	E	36.6	33.2	0.98	37.4	69.6
	Z	24.6	19.6	1.5	42.7	71
KRM2	N	68.2	48.4	1.2	41	94.5
	E	111.2	54	1.2	37.8	71.8
	Z	35.2	32.8	1.03	36.4	94.7

As a general rule, excitations considered to be aftershocks are defined with a characteristic distance from the mainshock and occur more often than the background level of seismicity [10]. The features of the distance in aftershocks is usually considered approximately one or two times of the length of the rupture, associated with the mainshock. For instance, if the mainshock ruptures a 50 km length of a fault, aftershocks are expected to occur within a 100 km-long elongated area around the fault ruptured with the first excitation [10-11]. In addition, the number of aftershocks is related to the magnitude of the mainshocks. Figure (2) shows the probability of the aftershock occur to the days after mainshocks. For instance, the probability of the aftershock occur in Point A, ten days after a mainshock, in the curve with the magnitude of 7, near the magnitude of the mainshock in Sarpol-e Zahab earthquake, is two times of the probability of that with the magnitude of 6.5 [10].

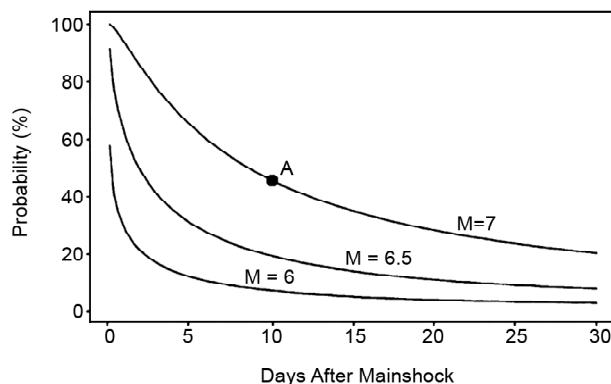

Figure 2. Probability of aftershock occur the days after mainshocks [10].

Actually, a structure damaged by a main shock may be incapable of resisting the excitations of a strong aftershock that increases the risk of major damage or building collapses. Therefore, it might be essential to evaluate fundamental infrastructures under these sequences to calculate the capability of structures under multi-excitations [12].

3. Damage of Buildings

3.1. Outline of Damage

In this area, the structures can be categorized into two general groups including structures in rural and urban area. According to the primarily investigation of the BHRC in Kermanshah

province, 320 thousands buildings had no structural frames (82%) and just 70 thousands buildings were occupied by the structural frames. Kermanshah province has a mix of newer RC structures, with modern detailing, and older non-ductile RC buildings [5].

Primarily reports indicated that the maximum number of casualties of Sarpol-e Zahab earthquake was in the Sarpol-e Zahab city. According to the building data collected in Iran Census 2011, the number of concrete buildings in the area affected by the earthquake has been shown in Figure (3) [13]. In addition, Figure (4) illustrates the distribution of damaged structures in Sarpol-e Zahab structures [14]. For example, Shahid Shiroudi Mehr buildings in the North-West of Sarpol-e Zahab, depicted in Figure (4), is a type of concrete structures with the high level of damage density. In Figure (5), some structural damage of this concrete structure have been illustrated.

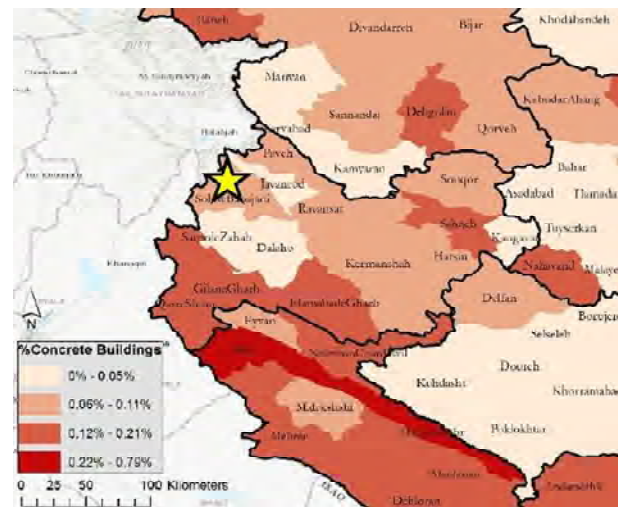

Figure 3. The number of concrete buildings in the area affected by the earthquake [13].

3.2. General Performance of Reinforced Concrete Structures

In fact, the most important lessons of the modern construction in the Sarpol-e Zahab earthquake are related to the performance of reinforced concrete buildings designed by past generations of Iranian National Building Codes, Design and Implantation of RC buildings, Part 9. In addition, a plethora of deficiencies in implementations and inappropriate materials used to build the RC structures components are some of the key factors to find out the reason

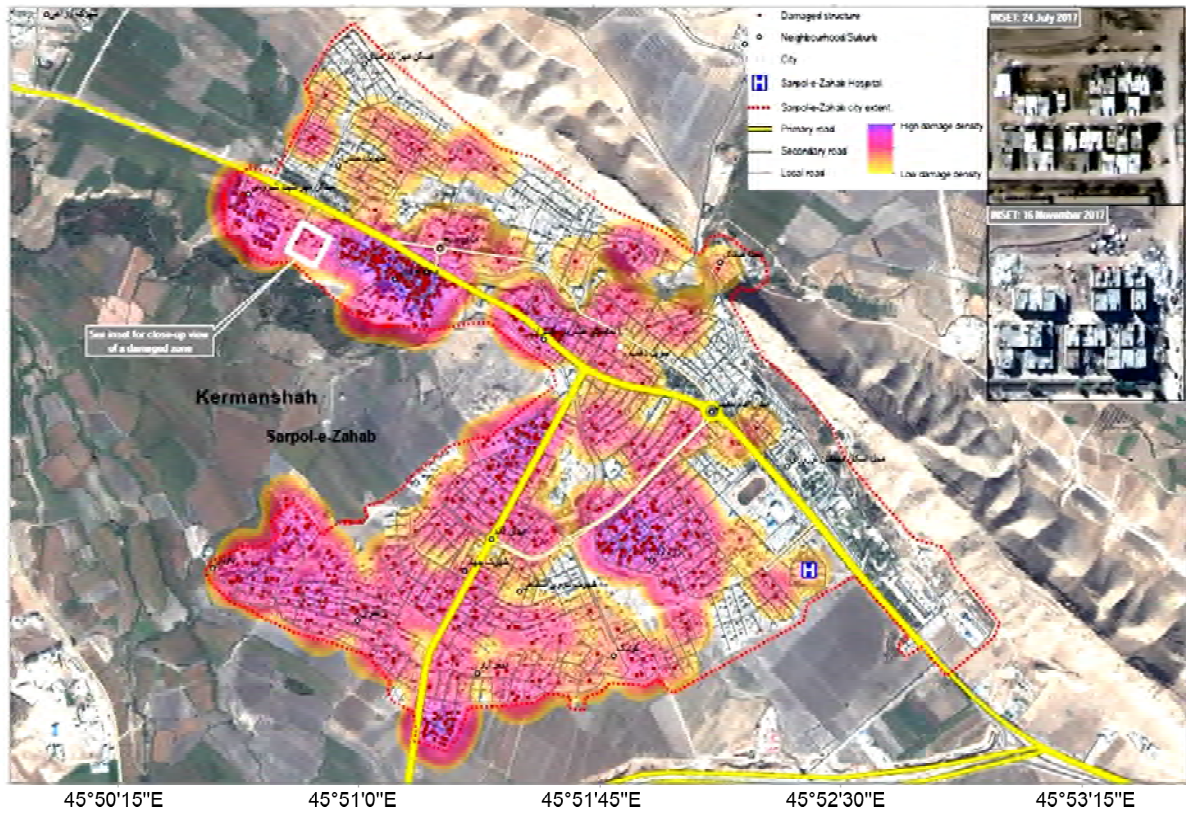

Figure 4. Distribution of damaged structures in Sarpol-e Zahab structures [14].



Figure 5. Sample of structural Damage in Sarpol-e Zahab, and Shahid Shiroudi Mehr buildings.

vast RC collapsed residential buildings in Kermanshah province and some fundamental RC structures in that area [8, 15-17].

The damage pattern by the non-ductile concrete frames during the Sarpol-e Zahab earthquake was the same as many catastrophic collapses experienced in past earthquakes such as common structural components deficiencies of non-ductile concrete including failures in beam-to-column joints without adequate transverse reinforcements, shear failures in concrete columns, axial demand failures in corner

columns, soft and weak story, pancake or torsional collapses, partial or complete collapse in staircases, etc. However, the moderate range of seismicity in this area, along with some case studies of recently retrofitted structures such as university, hospital and school buildings, offered some important insights into the critical building configurations, which can establish a concrete platform to improve design codes and implementation of infrastructures in Iran. Moreover, other reasons that lead to the severe damage of RC buildings illustrated in damaged RC structures are poor constructions of concrete materials, lack of sufficient technical and professional knowledge, and the inappropriate materials. The following provides a summary of the performance and some examples of failure modes of this type of structures, in the Sarpol-e Zahab earthquake. Besides, the recommendation to boost the seismic performance of RC structures would be indicated [8].

3.3. Soft Story

The soft story, as a type of irregularity based on the Table 12.3-2 in the ASCE/SEI 7-10 document, might occur in building floors with a significantly lower stiffness than the others [18].



Figure 6. Soft story collapse mechanism in 12th November 2017, Sarpol-e Zahab earthquake.

This irregularity, which commonly has unconsciously nature, might be generated due to the elimination or reduction in the number of rigid non-structural walls in one of the floors of a building, especially in the ground floor, by architectural considerations to provide the public access for functional necessity particularly in urban environments. In all parts of Iran, the developers might require the ground floors for commercial usages or even tear down the designed walls or columns on the ground floors and change the residential space to be commercial space such as a restaurant, a bank, a department store or to make the parking space. Figure (6) shows damage caused by this failure mode in Sarpol-e Zahab earthquake. Three examples of recent severe damage due to the soft story irregularity are in L'Aquila earthquake, Italy in 2009, in the residential complex "San Fernando" of low cost housing in Lorca, Spain in 2011, and the Villa Manrese convent in Haiti in 2010 [8, 19-20].

It should be noted that at the first moment after an earthquake, the buildings did not show apparent severe damage, though, all the buildings damaged by soft first story effects were pulled down. This clearly demonstrates the fact that the aftershock evaluation of infrastructures can play a key role in controlling these probable gaps. Maybe, the important infrastructures should occupy immediately after mainshocks and the advanced vulnerability assessment of structures subjected to aftershocks can reveal this type of imperfections [12, 19].

After this non-intentionally functional change, the stiffness and the strength of ground floors became weaker than other floors. In addition, the original

configuration designed based on seismic codes might be changed. As a result, large deformations of weakened floors might cause substantial P- Δ effects which can lead to plastic hinge formations in columns. It should be noted that if the soft story influences might not take into account in structural design, irreversible damage might trigger both the structural and nonstructural components including the local collapse, or even the total collapse of the building [8, 19-20].

Beams and columns in a moment frame structural system are likely to enhance the absorption and the dissipation of the energy capability. This means that the beam yielding is more preferable than the column yielding. Therefore, the beam-sway mechanism enhances the overall seismic resistance, because more plastic hinges are involved in developing the plastic collapse mechanism. In this paper, the title of "column-sway mechanism" and "beam-sway mechanism" have been chosen for these structural collapse mechanisms based on Bruneau et al. investigation [21]. Figure (7) illustrates the beam and column sway mechanism. Therefore,

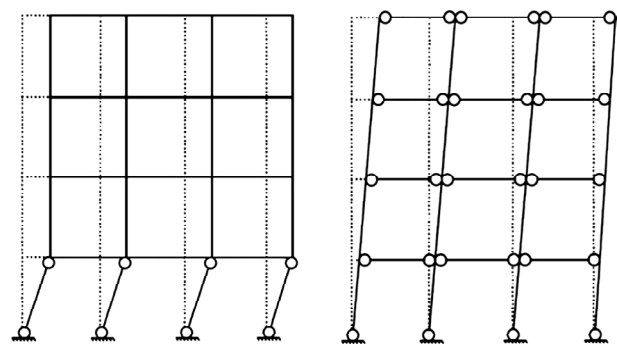

Figure 7. The beam and column sway mechanisms [21].

Seismic design codes recommend the phrase of "weak beam-strong column" as a practical way to reduce the probability of the collapse of structures by soft-story influences. The idea is that the beams and horizontal elements of the structure should break, creating plastic hinges, always before the columns. In addition, it is preferable that the beams in the upper levels always break before the beams of the lower levels. Therefore, creating plastic hinges in beams can enable the structure to dissipate the seismic energy without total collapse of the structure [21]. In the past generations of Iranian National Building Code, Design and Implantation of RC buildings, Part 9, particularly in the last edition published in 2013, in part 4-2-4-23-9, the flexural strength of columns should be 20% more than that of the adjoining beams as indicated in ACI 318-05 Sect. 21.4.2.2. This part has been proposed for the buildings designed for high ductility (special moment frame). However, there are not any limitations for ordinary and intermediate performance levels suggested in seismic design codes. A huge number of structures is residential, which can be categorized in intermediate or ordinary performance levels. It seems that Iranian National Building Codes can be equipped with provisions to mitigate the casualties caused by this failure mode in the future earthquakes [15-22].

3.4. Weak Story

This irregularity might be shown in a building floor with a lower lateral structural resistance (strength) than the immediate superior floor or the rest of the floors of the building. The weakest part of a building is not capable of resisting a spread spectrum of structural loads such as lateral, vertical, or rotational forces and moments subjected to excitations. Based on Table 12.3-2 in the ASCE/SEI 7-10 document, these types of irregularities are named Vertical Structural Irregularities. Weak story configuration is often illustrated in hospital or hotel buildings, in which not only the first floor is arranged with less walls than other floors, but also has greater heights than the rest of the floors [18-22].

A concrete failure due to the insufficient shear resistance is the most common type of failure in concrete structures, because shear failures are preceded with little deflections or cracks to give

advance warning. One of the most fundamental columns to satisfy shear capacity of structural elements in concrete structures is the compressive strength of concrete used to create structural sections. It should be noted that the shortage in the special compressive strength of the concrete can aggravate the probability of shear failures seen in Ezgeleh earthquake. Due to this paramount significance, the Iranian National Building Code, presents the minimum value of the compressive strength of the concrete equal to 20 (MPa) for RC structures with the intermediate ductility. Other factors which can play a key role to make this failure mode are the height of the weak-story, existence of mezzanine floor, rigidity and distribution of columns in weak-story, overhang and cantilever projection existence in weak-story, infill wall material properties, soil class and properties, floor number, seismic conditions [15, 23-27]. In Figures (8) and (9) the collapses caused by this failure method have been depicted.

In general, to mitigate the effect of this type of irregularity caused by wall affects, separating the infill panels from margin columns by gaps, and adding cross structural elements in the weak story can help the structure to withstand under strong ground motions. Figure (10) shows the rehabilitation methods proposed to improve the resistance factors of the weak-story [27].

3.5. Short Columns

Among reinforced concrete (RC) frame buildings with columns of different heights in one story, more damage have been seen in the shorter columns in



Figure 8. Earthquake damages caused by weak-story in Eslamabad Mehr buildings.



Figure 9. Fracture of a weak story RC column during the earthquake.

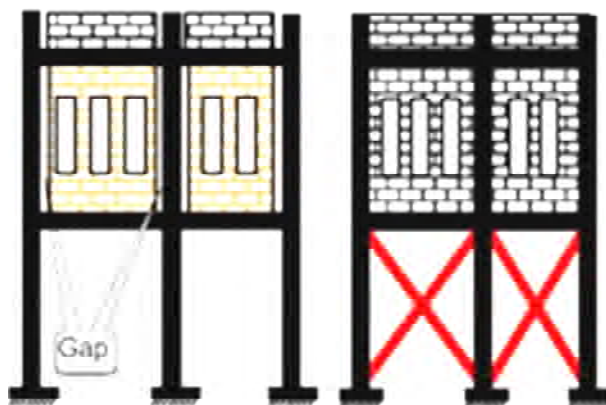

Figure 10. The rehabilitation methods proposed for this failure mode.

investigations during past earthquakes in comparison with taller columns in the same story. Many arrangements of columns in an RC structure can cause short column effect in buildings such as buildings on a sloping ground, or buildings with a mezzanine floor, and the RC columns broken by a beam supporting a stair landing. Another structural configuration in an RC structure that amplifies the short column effects is the existence of a wall of partial height that is built to fit a window over the remaining height with no initial gaps between the columns and the infill walls. The short column effects can be made by architectural or structural reasons [28-29].

Iranian Code of Practice for Seismic Resistant Design of Building (2800-the fourth edition), part 1-5-9 and 1-5-8, presents the limitations to prevent the short column effects; however, the difficulties in the implementations and incompatible design assumptions with the way of implementations, particularly regarding the preparation of pinned

supports at the end of the concrete elements, have made this effect as a common failure mode in all past earthquakes in Iran [30]. For instance, the examples of this type of failure in Sarpol-e Zahab Earthquake are depicted in Figure (11).

To reduce the short column effects in RC structures in the future, separating the infill walls from the boundary structural frames with adequate gaps that would help the column to bend freely, can be an effective way. In this case, it should be noted that to control the out-of-plane failure mode of infill walls, a steel beam with a U-shaped section between the infill wall and the RC frame can be implemented to prevent the infill panel failure in the out-of-plane direction [26-28].

3.6. Pancake Collapse

In many different regions of the world, the survey teams in post-earthquake investigations have reported an abysmal behavior of reinforced concrete buildings. The image reported by almost all teams is heavy and unyielding floors collapse one on top of the other with people trapped and crushed in between that is called "pancake" collapse. The pervasive image of floors piled one on top of another with the walls fallen away completely was heart-wrenching when one realized that between those floors lay the bodies of the occupants [31-32].

The progressive collapse of structures under seismic excitations can be classified into six types including pancake, zipper, domino, section, instability and mixed types, and different treatments should be carried out to prevent all types of collapses [31-32]. The main reason of this type of collapse is the lack of the gravity load resisting system. The



Figure 11. Short column effects in Sarpol-e Zahab, Mehr buildings.



Figure 12. The pancake collapse of structures under Sarpol-e Zahab earthquake.

initial collapse in vertical load-resisting elements, partial and complete separating of the roof system, and the failure of other components by the impacts and the weight of collapses can be the other characteristics of the pancake collapse [31-32].

Although deficient design and out-of-date construction methods are indeed a comprehensive explanation for many of the concrete building collapses, there are something fundamentally ambiguous with a pervasive reliance on a poor construction system for conventional building

projects and important infrastructures which depend on a spread spectrum of quality control levels. In every major earthquakes, particularly in developing area, this attitude regarding structures and constructions is so rarely achieved based on the large number of pancake collapse. On the contrary, the old and traditional buildings survived during the strong ground motions were not engineered and had been made with no plan [31-32]. In Figure (12) the samples of collapsed structures by this failure mode have been illustrated.

3.7. Torsional Collapse of Buildings

The irregularity on structures caused by improper construction methods and the poor design leads to a more complex structural behavior. Due to the complexity in seismic performance of structural systems, unpredictable and unexpected influences might be seen in irregular structures subjected to various excitations. Therefore, the irregular structure cannot satisfy the seismic design provisions and would suffer from immense damages as a result of torsional effects [33-36].

Excitations and forces caused by strong ground motions act at a point called "the center of mass" of structural floors. However, resisting forces perform at the center of lateral resistance named "center of rigidity" of the structures. Therefore, the differences between the center of mass and the center of rigidity can result in torsional problems for the structure. This difference has a direct relationship with the great torsional moments, which can twist the building around the rigid core. These great torsional moments are capable of causing extensive damage and uncontrollable failures in columns and

concrete walls named "Knife Cut" damage pattern. Figure (13) illustrates this type of failure mode in Sarpol-e Zahab earthquake [33-36].

3.8. Staircase Damages

Practically, the location of a staircase during the design process is determined by architectural engineers and the structural aspects of this part of the structure might be ignored. Therefore, it is so important for structural engineers to pay more attentions to the design of the staircases. For instance, a staircase at the corner of a structure without considering the local and general effects of that on the seismic performance of the structure can be a source of irregularity, which leads the structure to an unexpected structural and seismic behavior. Moreover, the imperfection in the implementation of staircase connections to the surrounded columns can have deteriorating effects on the seismic behavior of columns during earthquakes due to the brace performance of the staircases in lack of special joints to the columns. As shown in Figures (14) and (15), although there are



Figure 13. The torsional collapse of the structures subjected to Sarpol-e Zahab earthquake.



Figure 14. Staircases separated the structures by the brace performance due to poor implementations.



Figure 15. Staircases separated the structures at the level of first floor.

not any signs of damage in beams and columns in the structure, the staircase has been separated completely and the brace performance of that imposed this type of failure to staircases. It should be noted that the stability, proper design, and the accurate implementation of staircases can play a key role to reduce the number of casualties, particularly, in area with untrained people who use staircases to go out of the buildings during the earthquakes. Another reason caused a huge number of damaged staircases is the lack of appropriate joints to the surrounding columns. In Figure (16) the reinforcements have been pulled out because of ignoring the standard bending of bars at the conjunction of the staircase and the column. In addition, in some cases, the collapse of the staircases were due to the poor implementations in considering the adequate overlapped lengths [37].

To rehabilitate this part of the structure used in emergency activities after earthquakes, a solution has been presented in this paper as follows:

When an intermediate landing of a staircase is supported on a wall and other ends are rested on the span between columns, a gap on three sides of the

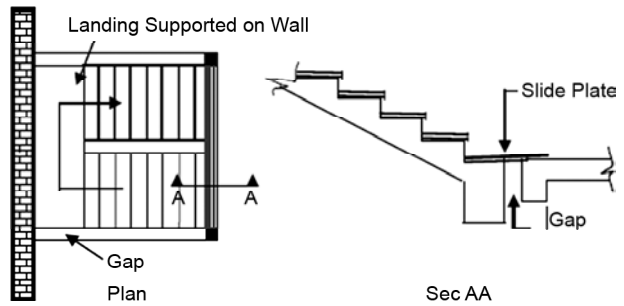

Figure 17. Rehabilitation method used to make a gap between the structure and the staircase [37].

staircase can be provided to separate it from the rest of the building. Therefore, the staircase with gaps covered by a slide plate in landings is capable of sliding and reducing the axial forces created by surrounding structural elements. It should be noted that the configuration of this method should allow inter-story displacement of the staircase in all directions. The general shape of this rehabilitation method has been illustrated in Figure (17) [37].

3.9. Punching Shear

Punching shear is a type of reinforced concrete slab failure subjected to high localized forces. In flat slab structures that occurs at column support points. This type of failure is catastrophic because of the lack of visible signs prior to the failure. Figure (18) illustrates punching collapse of an RC structure in Sarpol-e Zahab earthquake. The damage might be as a result of poor implementations of reinforced shear bars or low quality of the concrete used at the conjunction of the slab and the column [37].

3.10. Flexural Damage at Column Ends

Generally, the top and the bottom of a column are called critical regions that tolerate the maximum bending moment values under earthquakes excitations



Figure 16. Pulled out bars because of ignoring the standard bending of bars at the conjunction of the staircases and columns.



Figure 18. Punching shear in an RC structure during the 12th November 2017 earthquake.

in common structures. The design rules make plastic hinges at the top and the bottom of a column and due to this fact, the most sensitive parts that might be damaged are these two parts of a column.

Flexural damage always includes a visible horizontal crack and the loss of concrete cover, often accompanied by bar buckling, opening of stirrups or partial disintegration of the concrete core inside the cage of reinforcement; sometimes one or more vertical bars rupture, or the disintegrating in concrete core. In Figure (19), all types of



(a) Flexural Damage at the Top of the Column



(b) Loss of Concrete Cover That Caused by Flexural Damage



(c) Visible Horizontal Cracks That Caused by Flexural Damage



(d) Rapture of bars



(e) Column Failure with Buckled Longitudinal Bar and the Unequal Cover at the Slides of the Column



(f) Low Quality Materials

Figure 19. All types of flexural failures in Sarpol-e Zahab Earthquake.

flexural failures observed during Sarpol-e Zahab earthquake have been illustrated. For instance, in Figure (19d), imperfections to build the cover of columns unsymmetrically, might reduce the gross section area of the columns and the stress concentration in the layer of cover. Therefore, the core of the elements might play a role to separate some parts of the cover in the first cycle of earthquake and a significant amount of flexural capacity of the columns would be lost by the first cracks [8-40].

3.11. Shear Failure of Columns

A column might fail by shear forces in each place between its two ends due to the constant shape of shear forces along the height of the column. The signature of a shear failure is a diagonal crack in failure zones [37-39].

In Figures (20) to (22), this sign of shear failure has been seen by the survey team in Mehr buildings and the Imam Khomeini hospital of Eslamabad-e Gharb, respectively. The reason of this type of damage is the low quality of concrete and the poor implementations in considering the rules for shear reinforcements [37-39].

In a column with low axial load in the area of the cross section, the shear failure plan inclination to the horizontal axis is approximately 45 degree. Moreover, in the column, which is heavily loaded, this degree is about 60. To shed light on this matter, in Figure (20), the damaged column is in the first floor of a 5-story building. It seems that it might withstand large axial forces and, therefore, the heavily loaded column failed under shear forces by 60 degree cracks [37-39].

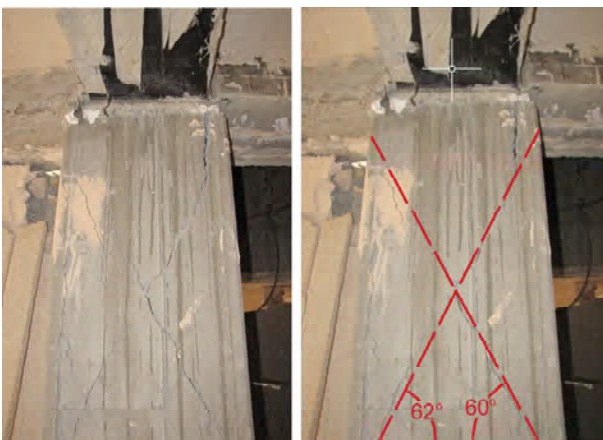

Figure 20. Diagonal cracks caused by shear forces (Eslamabad-e Gharb Mehr buildings).



Figure 21. Imperfections in implementation of transverse reinforcements, Eslamabad-e Gharb hospital.



Figure 22. Shear failure, Eslamabad-e Gharb Mehr building.

The cyclic nature of the earthquake on elements for shear, particularly in RC structures, is even more important than on elements for flexure. In fact, as the direction of the shear alternates, two "families" of diagonal cracks form, intersecting each other and leading to a very fast disintegration of the concrete. Additionally, since the horizontal stirrups are in tension for both directions of shear, diagonal cracks do not close upon reversal of the force; hence, the cracks become wider even more, causing a very fast degradation of the lateral stiffness and strength of the column, denoting as a "brittle failure" [37-39].

3.12. Beam-Column Joints

As shown in Figure (23), an earthquake induces a large number of shear stresses to the core of a beam-column joint. The effects of extra shear stresses are clearly manifested in exterior joints, especially corner ones, interior joints which can use the confinement of the slab on all four sides and the beams in each direction [37-39].

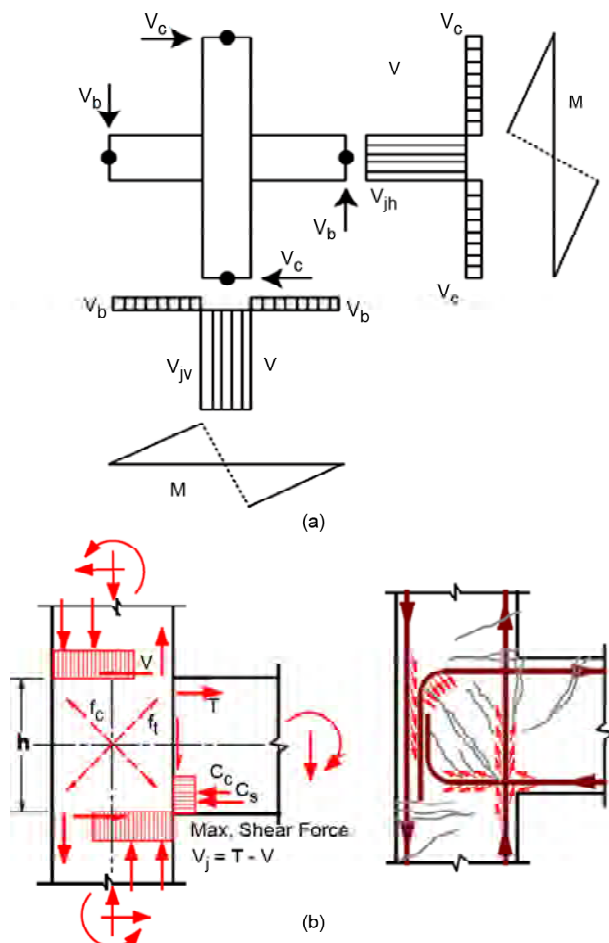

Figure 23. Seismic moments and shears in the beams and columns connected at a joint and seismic shears in the joint core [37].

The panel zone and the joints during strong ground motions should play a key role as force-control members. However, the maximum value of bending moments and shear forces at the joints force designers to use the high density of reinforcements in a small part; and therefore, this fact makes the implementation of joints more difficult. Figure (24) demonstrates the fact that shear failures in joints can cause progressive destruction in the structure [39].

Clearly, the cause of this failure has been illustrated in Figure (25). The elements with inadequate shear reinforcements cannot tolerate under cyclic loading protocols. This means that the lack of sufficient shear reinforcements can reduce the cyclic behavior of joints subjected to strong ground motions.

The lack of proper detailing of reinforcements in joints can induce more damages to the structure as follow:

- Sliding the bars in the concrete due to the low quality of concrete in the panel zone to make a coherent environment for reinforcements and concrete. This type of damage in Sarpol-e Zahab



Figure 24. The shear failures due to the lack of ductility in joints.

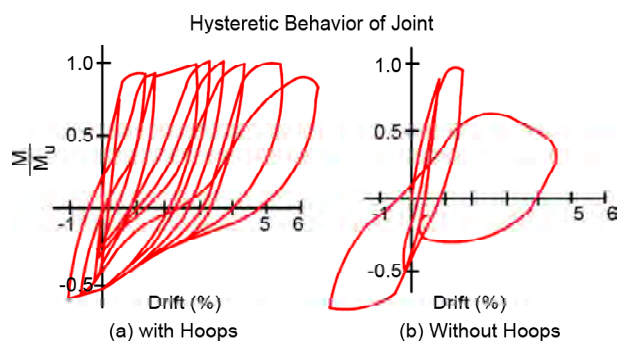

Figure 25. The cyclic behavior of joints with and without hoops subjected to loading protocols [37].

earthquake has been depicted in Figure (26).

- The fault in considering wider distance of transverse reinforcements near the panel zones can cause shear failure in structural elements as shown in Figure (27).



Figure 26. Sliding the bars in concrete due to the low quality of materials.



Figure 27. Imperfections in transverse reinforcements spacing in Eslamabad-e Gharb, Mehr buildings.



- Imperfection in using 90 degree hooks at the end of the longitude bars. Generally, in concrete components, in order to achieve ductile performance and transmit of the forces between concrete and the bars, it is essential to use hooks at the end of the structural components. The Iranian National Building Codes, Design and Implantation of RC buildings, Part 9, in sections 9-21-2-2 and 9-21-2-3 as Figure (28), present the rules that guarantee the seismic performance of the structural elements [8-17].

3.13. Beams

Beams might be destroyed by shear, bonding, or sliding cracks. Figure (31) shows this type of cracks in concrete beams in structures subjected to Sarpol-e Zahab earthquake. Other types of

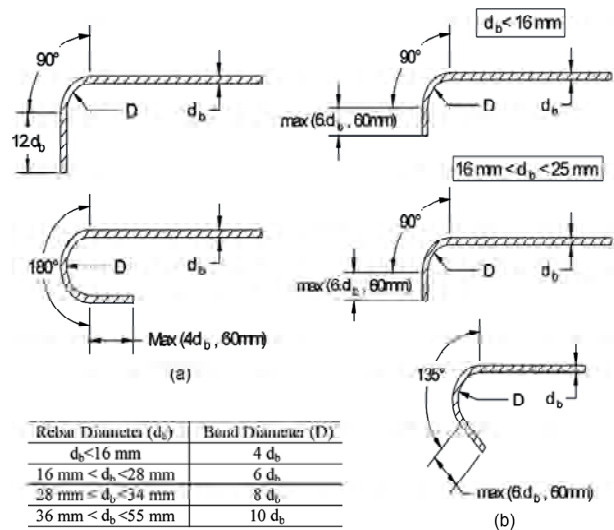

Figure 28. Bending and diameters of rebar according to Iranian National Building Codes, Design and Implantation of RC buildings, Part 9 [17].

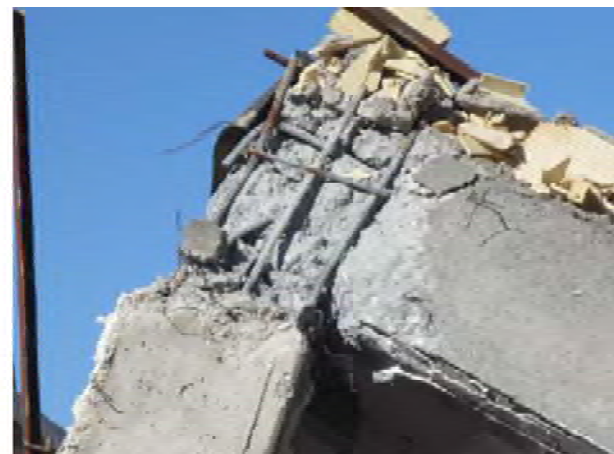

Figure 29. Imperfection in using 90 degree hooks at the end of the longitude bars.



Figure 30. Imperfection in using 135 degree hooks in transverse reinforcements.



Figure 31. Failure at the bottom flange of a beam with slab.

cracks are shrinkage cracks, torsion, tension, or flexure cracks.

Beams in moment frames are responsible for dissipating the induced energy to the structure by developing flexural plastic hinges and are expected to do so in an earthquake. A standard feature of flexural damage in plastic hinges is mostly associated with through-depth crack at the face of the supporting beam and cutting off of the concrete fragment and yielding of the reinforcement. In addition, flexural failure comes with disintegration of concrete beyond the cover, often with buckling (or even rupture) of bars. Figure (32) shows an



Figure 32. Damage patterns of RC beams under Sarpol-e Zahab earthquake [37].

occurrence at the bottom flange of a beam. It should be noted that the slab provides the top flange with abundant cross-sectional areas of the concrete and steel reinforcements [37].

3.14. Buckling of Reinforced Concrete Columns

Fundamental parameters participate in buckling of RC columns that can be categorized as: Axially loaded RC columns, the effective length of individual columns, eccentrically loaded RC columns, effective length of columns in frames, ways of considering the effect of inclination due to the construction imperfection, construction rules of columns, determining additional eccentricities by the use of design aids tables, and two independent checks. Figure (33) shows this type of failure in Eslamabad-e Gharb Mehr building.



Figure 33. Buckling of structural columns in Eslamabad-e Gharb, Mehr buildings.

3.15. Failure in the Concrete Slab

RC systems including ribbed slabs, cantilever staircase slabs, or flat slabs without stiffening by shear walls are susceptible to large lateral deflections and might suffer from heavy structural damages under strong earthquake. Failure of concrete cantilever slabs of staircase because of insufficient amount of slab reinforcement in Sarpol-e Zahab earthquake is illustrated in Figure (34).



Figure 34. Failure of concrete cantilever slabs of staircase.

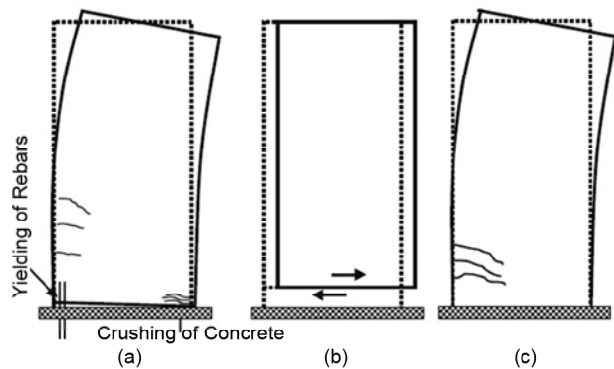

Figure 35. Typical failure modes of shear walls (a) Flexure failure, (b) Sliding failure, (c) Shear failure [37].

3.16. Examples of Damage to Concrete Wall Buildings

Perhaps some of the most important lessons for modern construction from the Sarpol-e Zahab earthquake is related to the performance of reinforced concrete wall buildings. Most shear walls in common buildings were tall slender walls due to the capacity

design concepts applied to guarantee the flexural yielding at the base level to limit the shear demands and adequate horizontal reinforcements was provided to avoid the shear failure in the plastic hinge zone. Although, based on the past investigation after earthquakes such as February 22, 2011 Christchurch earthquake, unexpected failures have indicated the need to improve design provisions of shear walls, almost all failures in Sarpol-e Zahab earthquake were due to the imperfection in implementations of shear walls. It means that the structures equipped with this structural system behave as well and the examples of failures were due to the low quality of concrete materials, and inadequate anchorage of horizontal and vertical reinforcements. The following provides a brief summary of some examples of failure modes observed after November 12, 2017, Sarpol-e Zahab earthquake. Typical failure modes of RC shear walls have been depicted in Figure (35) [29, 37].



Figure 36. The low quality of concrete used in Eslamabad-e Gharb, Mehr buildings.



Figure 37. The inadequate anchorage of longitude reinforcements in Eslamabad-e Gharb, Mehr buildings.



Figure 38. The failure of shear wall because of inadequate anchorage of longitude reinforcements in Eslamabad-e Gharb, Mehr buildings.

Although the plans of a lot of blocks of Eslamabad-e Gharb Mehr buildings are the same, two adjacent RC buildings built by a contractor have been damaged severely because of the low quality of concrete used in these structures. In Figure (36) the inappropriate concrete used to build shear walls in Eslamabad-e Gharb Mehr buildings has been depicted.

Figures (37) to (39) illustrate the web buckling of one outstanding leg of a shear wall in a 5-story building. In the first generation of Iranian National Building Code, Design and Implantation of RC buildings, Part 9, walls were not detailed for ductility; therefore, this fact results in inadequate horizontal and vertical reinforcement, particularly at critical regions in the walls. During the process of evaluations of past earthquakes, older walls actually do not have reinforcements to prevent the brittle confinement or buckling failures. Although this gap

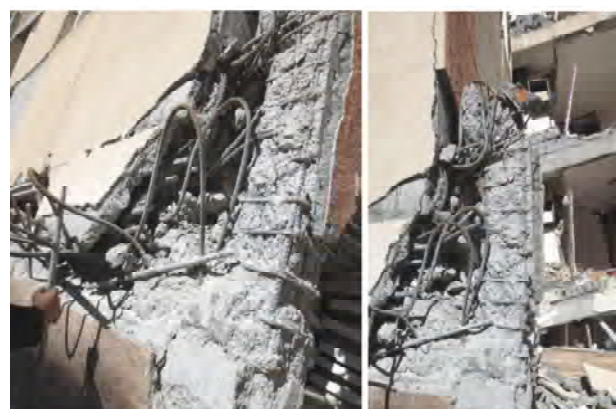

Figure 39. The imperfection in the continuity of boundary elements and the shear wall.

has been improved in new editions of Iranian National Building Codes, Design and Implantation of RC buildings, Part 9, the walls carried out for Eslamabad-e Gharb Mehr buildings due to the imperfections in implementation of the longitude of lap-splices, hooks, and the continuity of the wall and boundary elements have been suffered a huge damage [17].

It should be noted that the wide spacing of transverse reinforcements might lead to bar buckling prior to bar fracture. The architectural design of the building, in which using numerous walls make it possible to achieve the higher base shear, required for a low ductility structural system and thus this can provide an opportunity to carry out without the needs for full ductile detailing. In some reinforced shear walls, the symptoms of flexural cracking and the bar fracture of longitudinal bars have been detected after removing the concrete cover. It is needless to say that engineers in post-earthquake field investigation should be cautious when assessing the extent of damage to lightly reinforced shear walls. Figure (39) illustrates the buckling of longitude bars in the walls due to the lack of adequate transverse reinforcement [37-39]

4. Conclusion

This paper presented a brief summary and overview of preliminary lessons learned from our observations of the seismic performance of RC buildings in the November 12, 2017, Sarpol-e Zahab earthquake. Due to this paramount significance, the concise nature of the article cannot make a comprehensive discussion of all aspects and backgrounds in detail. In Sarpol-e Zahab earthquake, not only the private and low-rise buildings without any structural frames, but also the public RC buildings such as Eslamabad-e Gharb hospital have suffered severe damages. The investigations and conclusions extracted from the damaged structures of this earthquake would give architect and structure engineers a great lesson of seismic safety of RC buildings.

According to the experience of damage evaluations in Sarpol-e Zahab earthquake, the root cause of damages can be categorized in three general aspects including design provisions and requirements, materials such as aggregates, bars, cements etc., and

the implementations and technical profession.

The damages caused by imperfections in designs are weak column - strong beam, short or captive column effects, inaccurate design of staircases, and the incompatibility of the ductility and performance levels. Besides, the low quality of the concrete could result in the low special compression strength of concretes. Shear failures of columns, investigated by the survey team, have revealed that in some cases, instead of the wide spacing of transverse reinforcements, the low quality of the concrete was the reason for the failure and the buckle of the columns. Among all imperfections in technical professions, the unequal thickness of the cover in both side of the column sections, wide spacing of transverse reinforcements, the bending and the hook of horizontal and the vertical bars, the faults in joints, and the connections of nonstructural elements to the structural frames are the most important problems.

The authors of this article believe that moving toward the damage control approaches or using low-damage methods for new structures and the rehabilitations of existing structures by performance based-design attitude and also, favoring the implementation by training to boost the mental and technical professions besides developments of experimental and analytical seismic performance of concrete structures can guarantee the earthquake-proof buildings.

Acknowledgements

Special thanks go to the numerous professional structural engineers, Urban Search & Rescue Teams and IIEES survey team who assisted in various forms during the critical emergency period of these earthquakes. Any conclusions and inappropriate mistakes in reporting made in this report are nevertheless to be considered entirely those of the authors.

The management of the reconnaissance, training the domestic structural engineers, and field investigations to collect data of IIEES team under supervision of Dr. Behrokh Hosseini Hashemi, are gratefully acknowledged.

References

1. Yekrangnia, M., Eghbali, M., Seyri, H., Panahi,

- M., Zanganeh, S.Y., Beyti, M., and Hayatgheybi, S.V. (2017) A preliminary report on school buildings performance during M 7.3 Ezgeleh, Iran earthquake of November 12, 2017. Organization for Development, Renovation and Equipping Schools of I.R. Iran (DRES), DRES Earthquake Report - November 2017, <https://www.eeri.org/2017/11/halabjah-iran>.
2. www.isna.ir/news.
 3. Zare, M., Kamranzad, F., Parcharidis, I., and Tsironi, V. (2017) *Preliminary Report of Mw 7.3 Sarpol-E Zahab, Iran Earthquake on November 12, 2017*. European-Mediterranean Seismological Centre (EMSC), <https://www.emsc-csem.org>.
 4. Eslami, A., Mahmoudi Kohi, A., Taghaboni, M., and Kamizi, A. (2017) *Preliminary Report of the Earthquake on November 12, 2017, Sarpolzahab, Kermanshah Province*. IIEES (in Persian).
 5. Road, Housing & Urban Development Research Center (BHRC) (2017) *Immediate-Preliminary Report on 12th November 2017, Earthquake in Sarpol-e Zahab, Kermanshah Province, November 2017* (in Persian).
 6. IIEES (2017) *Report of the Earthquake on November 12, 2017, Sarpolzahab, Kermanshah Province, First Part; Seismological Aspects*. International Institute of Earthquake Engineering and Seismology, fifth edition.
 7. IIEES (2017) *Report of the Earthquake on November 12, 2017, Sarpolzahab, Kermanshah Province, Second Part; Geotechnical Aspects*. International Institute of Earthquake Engineering and Seismology, Fifth Edition.
 8. IIEES (2017) *Report of the Earthquake on November 12, 2017, Sarpolzahab, Kermanshah Province Third Part; Structures and Lifelines Aspects*. International Institute of Earthquake Engineering and Seismology (IIEES), Fifth Edition.
 9. Iran Strong Motion Network, Building & Housing Research Center (BHRC).
 10. Applied Technology Council (ATC) (1999) *Earthquake Aftershocks - Entering Damaged Buildings, ATC-35 TechBrief 2*. Last visit: <https://www.atcouncil.org/atc-pdf/atc35tb2.pdf> (June 2008).
 11. Yeo, G.L. and Cornell, C.A. (2009) A probabilistic framework for quantification of aftershock ground-motion hazard in California: Methodology and parametric study. *Earthquake Engineering and Structural Dynamics*, **38**(1), 45-60.
 12. Hosseini Hashemi, B. and Naserpour, A. (2014) Performance evaluation of the damaged steel moment frames under mainshock-aftershock sequences considering plastic hinge modification factors. *Journal of Seismology and Earthquake Engineering (JSEE)*, **16**(4), 261-270.
 13. Earthquake Engineering Research Institute (EERI) (2017) *Distribution of Building Types in the Earthquake Affected Regions of Iran by Sahar Derakhshan (VERT)*. <https://www.eeri.org/2017/11/halabjah-iran>.
 14. <https://unitar.org/unosat/maps/IRN>.
 15. Calvi, G.M., Pinho, R., Magenes, G., Bommer, J.J., Restrepo, L.F., and Crowley, H. (2006) Development of seismic vulnerability assessment methodology over the past 30 years. *Journal of Earthquake Technology*, ISET, Paper No. 472, **43**(3), 75-104.
 16. Iranian National Building Codes, Design and Implantation of RC buildings, Part 9 (2009).
 17. Iranian National Building Codes, Design and Implantation of RC buildings, Part 9 (2013).
 18. ASCE (2010) *Minimum Design Loads for Buildings and other Structures*. ASCE 7, Reston, VA.
 19. Paultre, P., Calais, E., Proulx, J., Prépetit, C., and Ambroise, S. (2013) Damage to engineered structures during the 12 January 2010, Haiti (Léogâne) earthquake. *Canadian Journal of Civil Engineering*, **40**(8), 777-790.
 20. Teshigawara, M., Fukuyama, H., Kato, H., and Inukai, M. (2001) *Building Damages in Taiwan Chi-Chi Earthquake*. NIST, Special Publication, 479-494.

21. Bruneau, M., Uang, C.M., and Sabelli, R. (2011) *Ductile Design of Steel Structures*. McGraw-Hill companies, ISBN 978-0-07-162395-7.
22. ACI Committee (2008) *Building Code Requirements for Structural Concrete (ACI 318-08) and Commentary*. American Concrete Institute, & International Organization for Standardization.
23. Arslan, M.H. and Korkmaz, H.H. (2007) What is to be learned from damage and failure of reinforced concrete structures during recent earthquakes in Turkey? *Engineering Failure Analysis*, **14**(1), 1-22.
24. Schiff, A.J. and Tang, A.K. (2000) *Chi-Chi, Taiwan, Earthquake of September 21, 1999: Lifeline Performance*. **18**, ASCE Publications.
25. Swaminathan, K., Chen, J., Komatitsch, D., and Tromp, J. (2006) Case studies of damage to tall steel moment-frame buildings in southern California during large San Andrea's earthquakes. *Bulletin of the Seismological Society of America*, **96**(4A), 1523-1537.
26. Cagatay, I.H. (2005) Failure of an industrial building during a recent earthquake in Turkey. *Eng. Fail. Anal.*, **12**(4), 497-507.
27. Kadysiewski, S. and Mosalam, K.M. (2008) *Modeling of Unreinforced Masonry Infill Walls Considering In-Plane and Out-of-Plane Interaction*, PEER 2008/102, University of California, Berkeley.
28. Lew, H.S. (1990) *Performance of Structures During the Loma Prieta Earthquake of October 17, 1989 (NIST SP 778)*. Special Publication (NIST SP)-778.
29. Kam, W.Y., Pampanin, S., and Elwood, K. (2011) *Seismic Performance of Reinforced Concrete Buildings in the 22 February Christchurch (Lyttleton) Earthquake*.
30. Building and Housing Research Center (2015) *Iranian Code of Practice for Seismic Resistant Design of Buildings (Standard 2800)*. 4th Edition, BHRC, Iran (in Persian).
31. Langenbach, R. (2006) Preventing pancake collapses: Lessons from earthquake-resistant traditional construction for modern buildings of reinforced concrete. *International Disaster Reduction Conference (IRDC)*, Davos, Switzerland, p. 44.
32. Yi, L., Lu, X., Guan, H., and Ye, L. (2011) An improved tie force method for progressive collapse resistance design of reinforced concrete frame structures. *Engineering Structures*, **33**(10), 2931-2942.
33. Gokdemir, H., Ozbasaran, H., Dogan, M., Unluoglu, E., and Albayrak, U. (2013) Effects of torsional irregularity to structures during earthquakes. *Engineering Failure Analysis*, **35**, 713-717.
34. Moehle, J.P., Hooper, J.D., and Lubke, Ch.D. (2008) *Seismic Design of Reinforced Concrete Special Moment Frames*. US Department of Commerce.
35. Saatcioglu, Murat, Denis Mitchell, René Tinawi, N. John Gardner, Anthony G. Gillies, Ahmed Ghobarah, Donald L. Anderson, and David Lau. (2001) The August 17, 1999, Kocaeli (Turkey) Earthquake Damage to Structures. *Canadian Journal of Civil Engineering*, **28**(4), 715-737.
36. Haj Seiyed Taghia, S.A., Ebrahimi, M., and Moghadam, A.S. (2016) Evaluation of torsional single story structure during earthquake according to Canadian provision. *Journal of Structural Engineering and Geo-Techniques*, **6**(1), 1-8.
37. Vetr, M.Gh. et al. (2017) *Design of Seismic-Resistant Steel and RC Connections*. ISBN: 978-600-04-6919-1.
38. Morgan, T.A. and Walters, M.T. (2004) *Innovative Approaches to Performance-Based Seismic Rehabilitation of Concrete Buildings*. Pacific Earthquake Engineering, **89**.
39. Jiang, H.J., Gao, H.Y., and Wang, B. (2012) Seismic damage analyses of staircases in RC frame structures. *Advanced Materials Research*, **446**, 2326-2330.